

1.  Note that the top margin is cutting off the top of the title block. The margins are controlled in the plot device settings.

2.  RMB over the Plan layout tab.  
Select **Plot**.

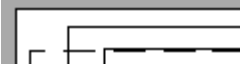
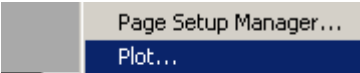
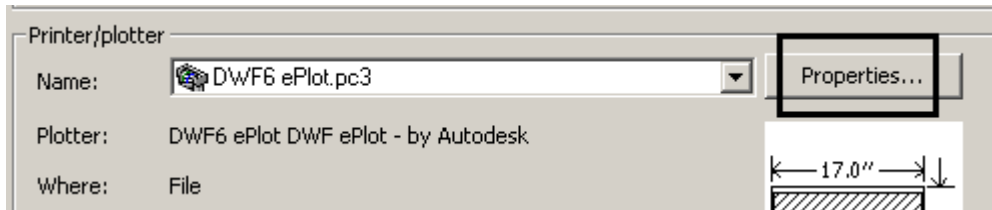
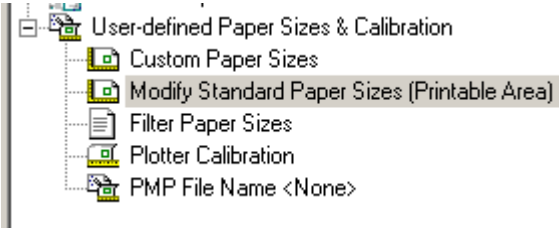

3. Select **Properties**.

4.  Highlight the **Modify Standard Paper Sizes (Printable Area)**.

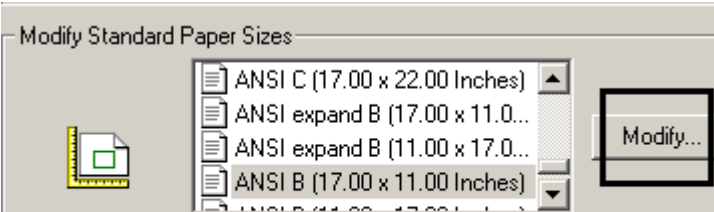
5.  Locate the **ANSI B** paper size.  
Highlight and select **Modify**.

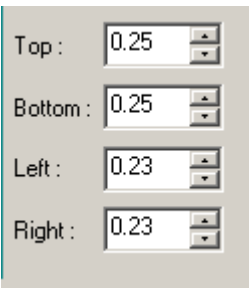
6.  Set the top and bottom margins to **0.25**.

Press **Next**.

7.  Accept the default PMP name.

Press **Next**.

8. Press **Finish** and **OK**.

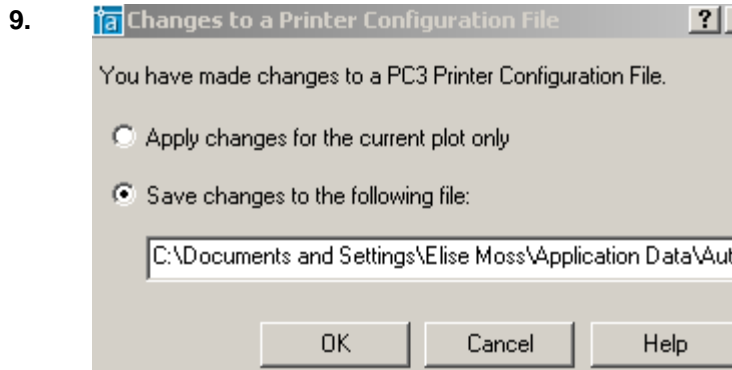

To make the changes permanent save them to the file.

If you only want the margins changed for this plot, enable that option.

Press **OK**.



Select **Preview**.

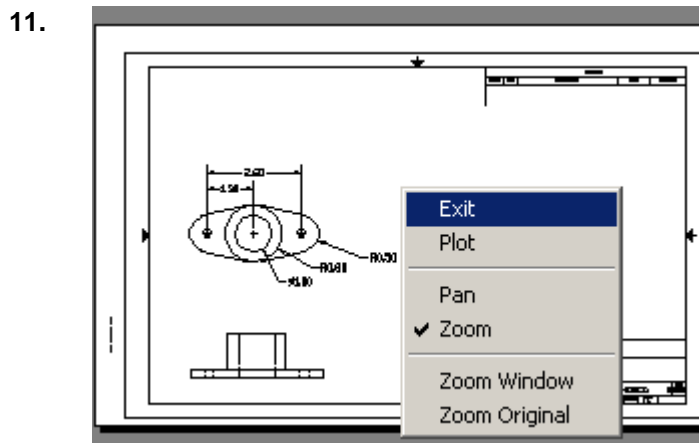

The plot now looks acceptable.